

HDMI 1.4 Switch

User manual

Thank you for purchasing this product. For optimum performance and safety, please read these instructions carefully before connecting, operating or adjusting this product. Please keep this manual for future reference.

I. Introduction

This is a high performance 3 or 4 HDMI input and 1 HDMI output switch. It supports HDCP repeater functions and fast switching between any of the HDMI input ports. The system supports all 3D TV formats in addition to all HDTV formats up to 4Kx2K. Furthermore, the remote control gives users complete control over the selection of sources and makes the device incredibly user friendly.

II. Features

Compliant with HDMI 1.4a, CTS 1.4a, DVI 1.0 standards.

HDMI 1.4 support: 3D TV support.

Support 3D Video & 4Kx2K, 8, 10, 12 & 16 bits per color depth.

Audio support:

Dolby TrueHD

DTS-HD Master Audio 7.1CH

Low power consumption, does not require an external power supply

III. Package

HDMI 1.4 4by1 Switcher

5V USB to DC Power Supply cable

Remote control

IR Receive Extend cable

Operation Manual

IV. Specifications

Frequency Bandwidth	2.97Gbps
Input Ports	3 or 4 HDMI Female ports, IR Receive port
Output port	1 HDMI Female port
HDMI Audio Output	PCM2, 5.1, 7.1CH, Dolby 5.1, DTS5.1, D-TrueHD, DTS-HD
ESD Protection	Human Body Model: $\pm 8\text{kV}$ (air-gap discharge) $\pm 4\text{kV}$ (contact discharge)
Dimensions (mm)	87(D) x59.5 (W) x 19(H)
Weight (g)	60
Power Consumption	0.2W
Operating Temperature	$0^{\circ}\text{C} \sim 40^{\circ}\text{C}$ / $32^{\circ}\text{F} \sim 104^{\circ}\text{F}$
Storage Temperature	$-20^{\circ}\text{C} \sim 60^{\circ}\text{C}$ / $-4^{\circ}\text{F} \sim 140^{\circ}\text{F}$

V. 3×1 Switch Operation controls and Functions

Face Panel: ①Switch button, press the button will switch the input source;

②③④Led indicate , Indicates the HDMI input port selected corresponding to the light.

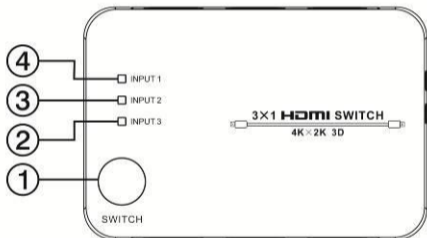

Front Panel: HDMI output port, connect with HDTV or monitor with HDMI cable

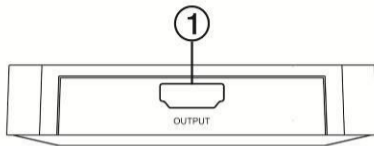

Rear Panel: HDMI input port, connect with DVD, PS3, Set-top Box and Note Book with HDMI cable

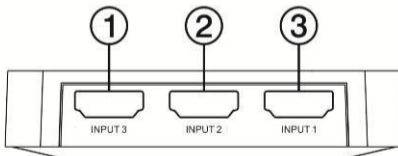

Right Panel: ①DC 5V input port;

②IR receiver port: connect a IR extend cable and receiver the Remote signal.

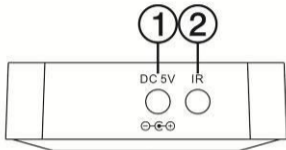

VI. 5×1 Switch Operation controls and Functions

Face Panel: ①Switch button, press the button will switch the input source;

②③④⑤⑥Led indicate , Indicates the HDMI input port selected corresponding to the light.

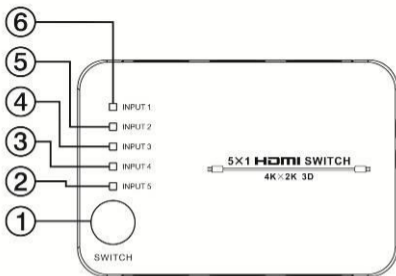

Front Panel: ①③HDMI input port, connect with DVD, PS3,Set-top Box and Note Book with HDMI cable

②HDMI output port, connect with HDTV or monitor with HDMI cable

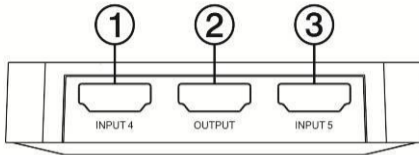

Rear Panel: HDMI input port, connect with DVD, PS3, Set-top Box and Note Book with HDMI cable

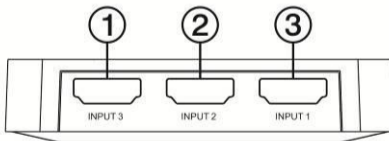

Right Panel:①DC 5V input port;

②IR receiver port: connect a IR extend cable and receiver the Remote signal.

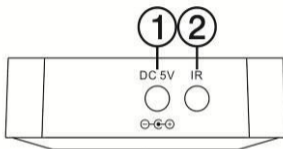

VII. Application Example (3×1 Switch)

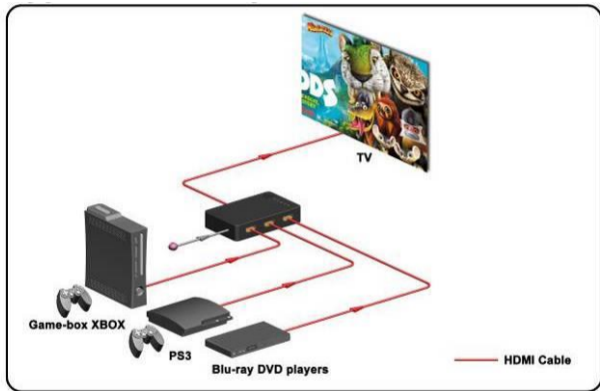

Application Example (5×1 Switch)

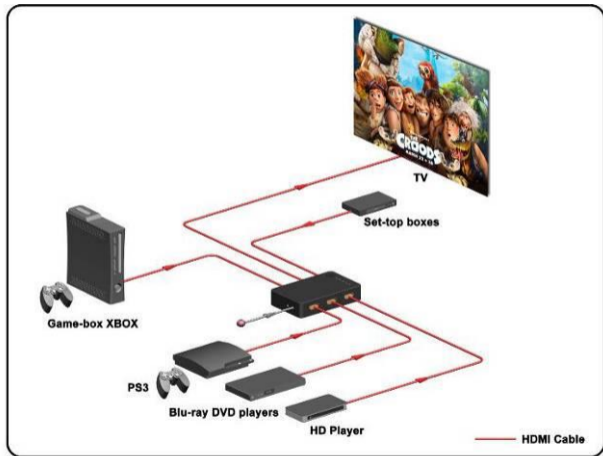

VIII. Remote control

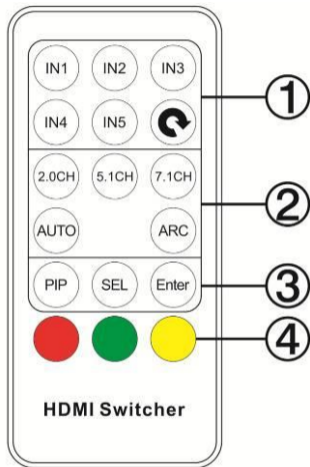

① IN1、IN2、IN3、IN4、IN5: Press this button will force switch the input port and the LED will indicate the corresponding input source. Note: IN4、IN5 in 3×1 Switch product is no function.

②: Press this button will cycle switch the input source and the LED will indicate the corresponding input source.

③④ is no function.